

SEIKO

DIGITAL QUARTZ

Cal. L423A

PARTS LIST

Cal. L423A



4001 183



4219 181



4245 181



4270 181



4313 180

☆4510 051



4521 181



☆SEIKO TR721SW

Cal. L423A

Characteristics:

Casing diameter: ϕ 16.0 mm
 Maximum height: 3.4 mm without battery
 Frequency of quartz crystal oscillator: 32,768 Hz (Hz=Hertz. . . . Cycles per second)
 Time and calendar display: Digital display system showing hour (12-hour indication), minute, second, month, date and day of the week.
 Display medium: Nematic Liquid Crystal, FE-Mode.
 Regulation system: Trimmer condenser
 Battery life indicator: All the digits in the display begin flashing.

PART NO.	PART NAME	PART NO.	PART NAME
4001 183	Circuit block		
4219 181	Battery connection insulator		
4245 181	Switch spring		
4270 181	Battery connection (-)		
4313 180	Connector		
☆4510 051	Liquid crystal panel		
☆4510 052	Liquid crystal panel		
4521 181	Reflecting mirror		
☆SEIKO TR721SW ☆SEIKO SB-DK ☆Nihon-Denchi SR721SW	Silver (II) oxide battery		
	Silver oxide battery		

Remarks:

Liquid crystal panel

☆4510 051 } Be sure that combination between the color of panel cover and liquid crystal panel
 ☆4510 052 } should be matched according to the "SEIKO Quartz Casing Parts List".

Battery

☆SEIKO TR721SW } The substitutive battery might be added to the applied battery in the future.
 ☆SEIKO SB-DK } In that case, please refer to separate "BATTERY LIST FOR SEIKO
 ☆Nihon-Denchi SR721SW } QUARTZ WATCHES". Note that SEIKO battery is marked with
 "SEIZAIKEN" on its (+) side.

☆ ⇨ Please see remarks.

Part numbers in light letters are not shown in photos.

TECHNICAL GUIDE

SEIKO DIGITAL QUARTZ

CAL.L423A

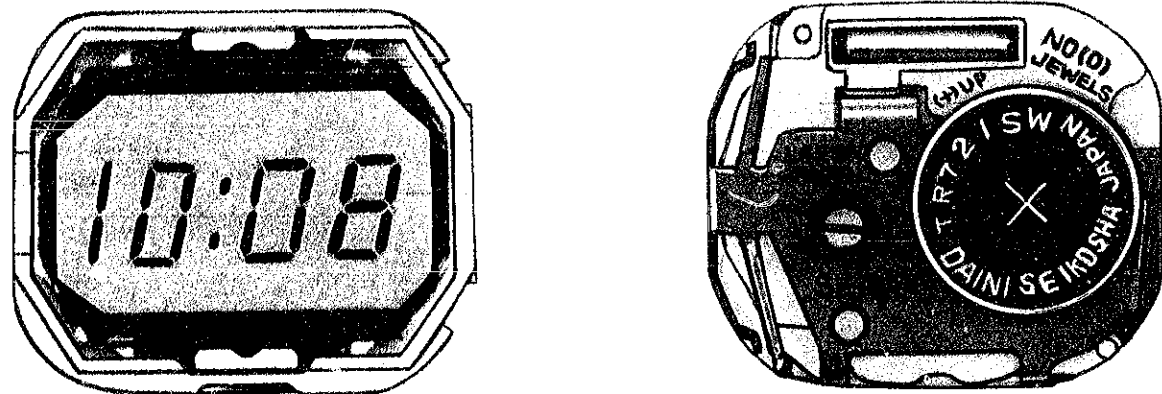

CONTENTS

I. SPECIFICATIONS	1
II. STRUCTURE OF THE CIRCUIT BLOCK	1
III. DISASSEMBLING AND REASSEMBLING	2
1. Liquid crystal panel side	2
2. Switch mechanism	3
3. Segment (Liquid crystal panel electrode)	4
IV. CHECKING AND ADJUSTMENT	5
• Check battery voltage	5
• Check pattern segment checking system	5
• Check conductivity of liquid crystal panel, circuit block and connectors	5
• Check liquid crystal panel and circuit block	5
• Check current consumption	6
• Check conductivity of switch components	6
• Check accuracy	6
• Check functioning and adjustment	6

I. SPECIFICATIONS

Item	Cal. No.	L423A
Display medium		Nematic Liquid Crystal, FEM (Field Effect Mode)
Liquid crystal driving system		Multiplex driving system
Display system		Time and calendar function (The display is shown for 2 seconds automatically in the following order by depressing a button. Second - Month/Date - Day)
Additional mechanism		Battery life indicator
Loss/gain		Loss/gain at normal temperature range Monthly rate : less than 15 seconds (Annual rate : less than 3 minutes)
Casing diameter		φ16.0mm (13.0mm between 6 o'clock and 12 o'clock sides) 15.5mm between 3 o'clock and 9 o'clock sides)
Height		3.4 mm without battery
Regulation system		Trimmer condenser
Measuring gate by Quartz Tester		Any gate is available.
Battery		SEIKO (SEIZAIKEN) TR721SW or SB-DK, or Nihon-Denchi SR721SW Battery life is approximately 2 years. Voltage: 1.55V

II. STRUCTURE OF THE CIRCUIT BLOCK

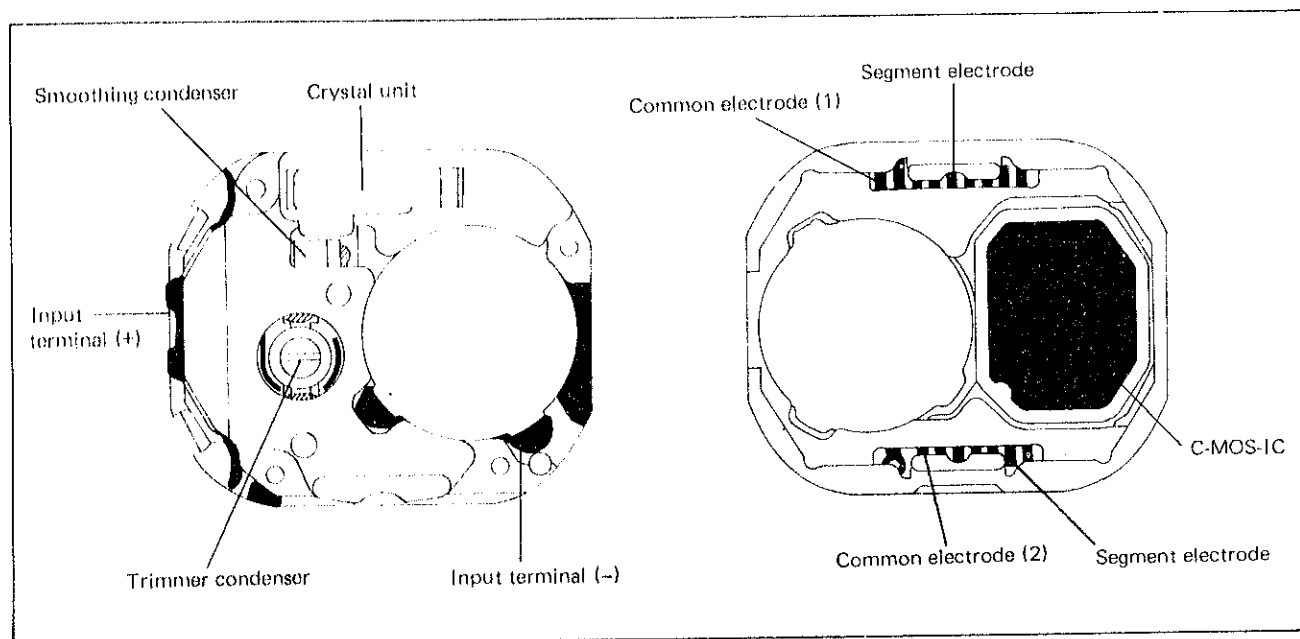

III. DISASSEMBLING AND REASSEMBLING

Disassembling procedures Figs.: ① → ⑦

Reassembling procedures Figs.: ⑦ → ①

1. Liquid crystal panel side

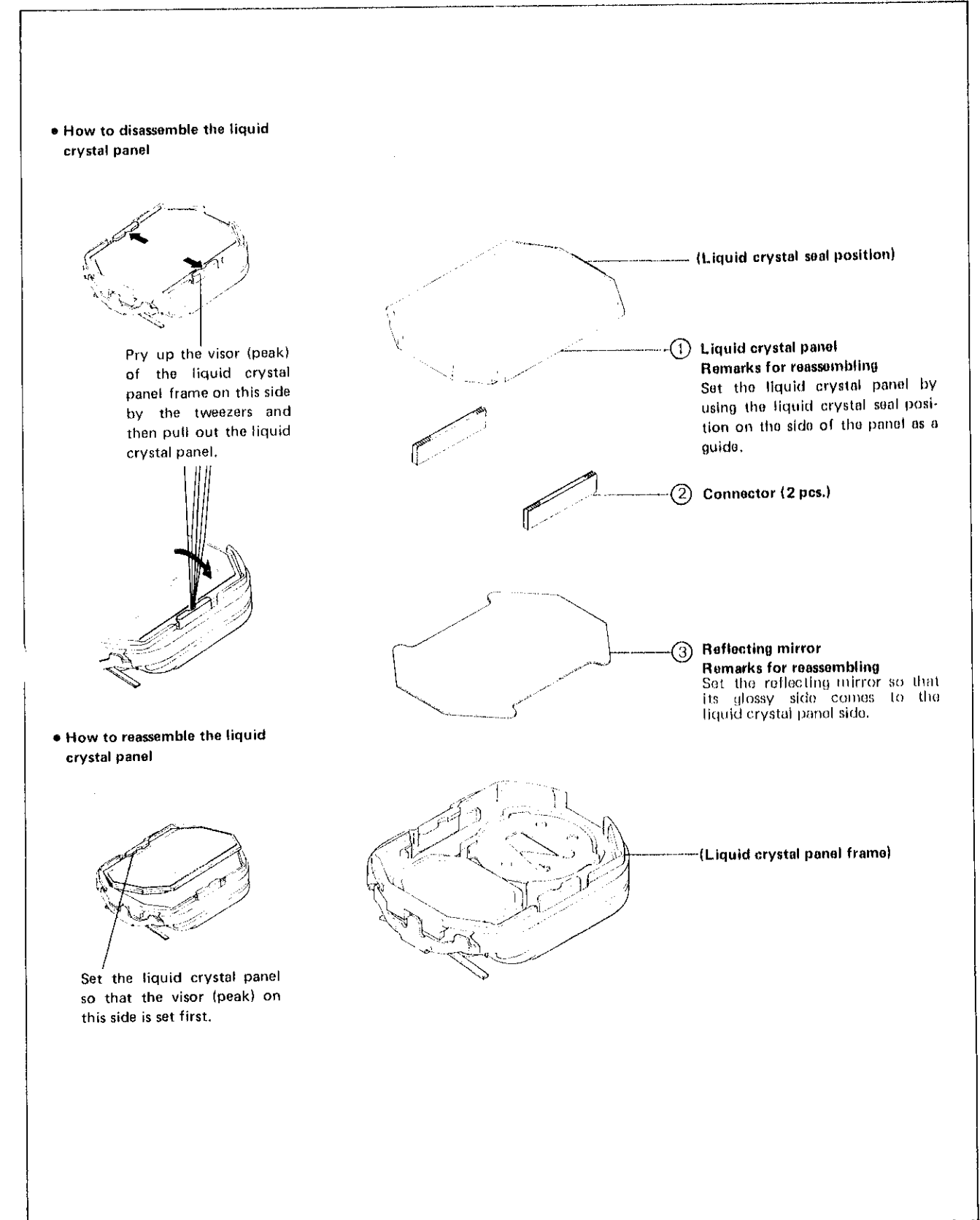

2. Switch mechanism

• How to disassemble the switch spring

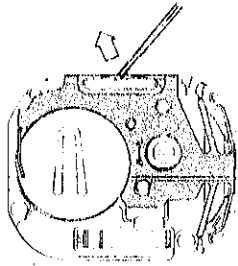

Put the tip of the tweezers in the clearance between the battery guard and switch spring and pry up the switch spring for disassembling.

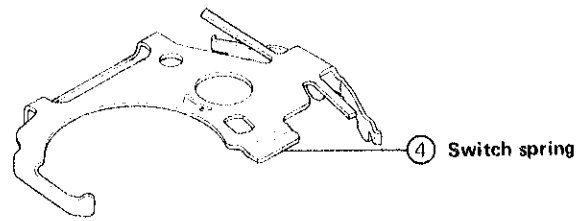

• How to reassemble the switch spring

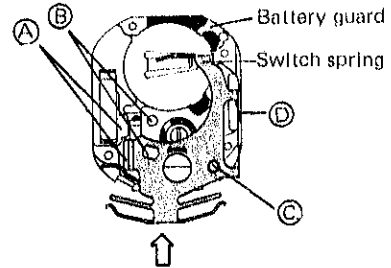

While sliding the switch spring from the arrow-mark direction, set the A and B portions in the battery guard.

Then, while setting C portion by pushing the switch spring from the side, push D portion by the tweezers and set the switch spring into the battery guard.

• How to reassemble the battery connection (-) and the battery connection insulator.

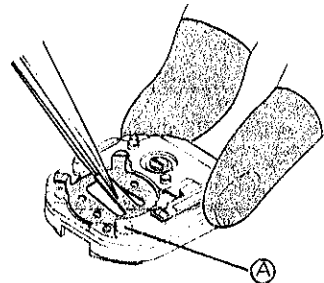

• Set A portion of the battery connection (-) under the battery guard as shown in the illustration above.

• Set the battery connection insulator on the battery connection (-) according to the same procedures.

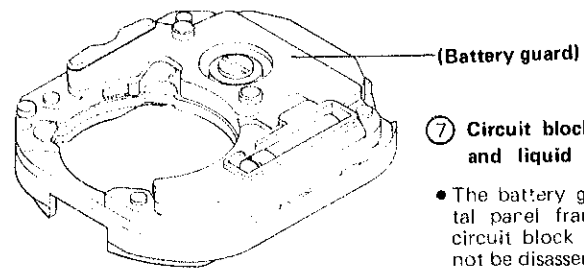
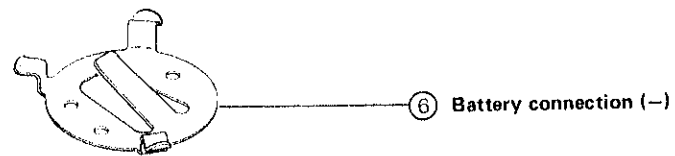
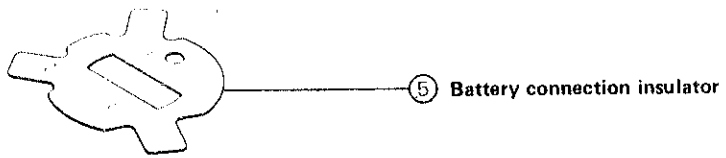



7 Circuit block (with battery guard and liquid crystal panel frame)

• The battery guard and liquid crystal panel frame are fixed on the circuit block tightly and they cannot be disassembled.

3. Segment (Liquid crystal panel electrode)

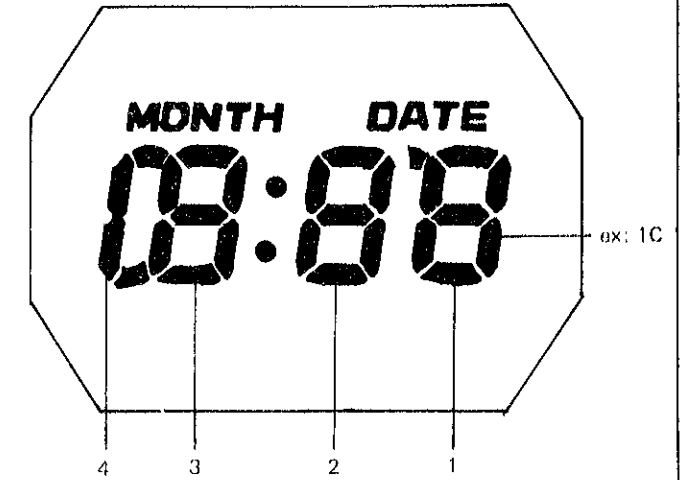
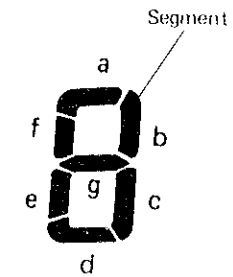
• Designation of segment



Common electrode 1 is connected electrically with  segment.
Common electrode 2 is connected electrically with  segment.

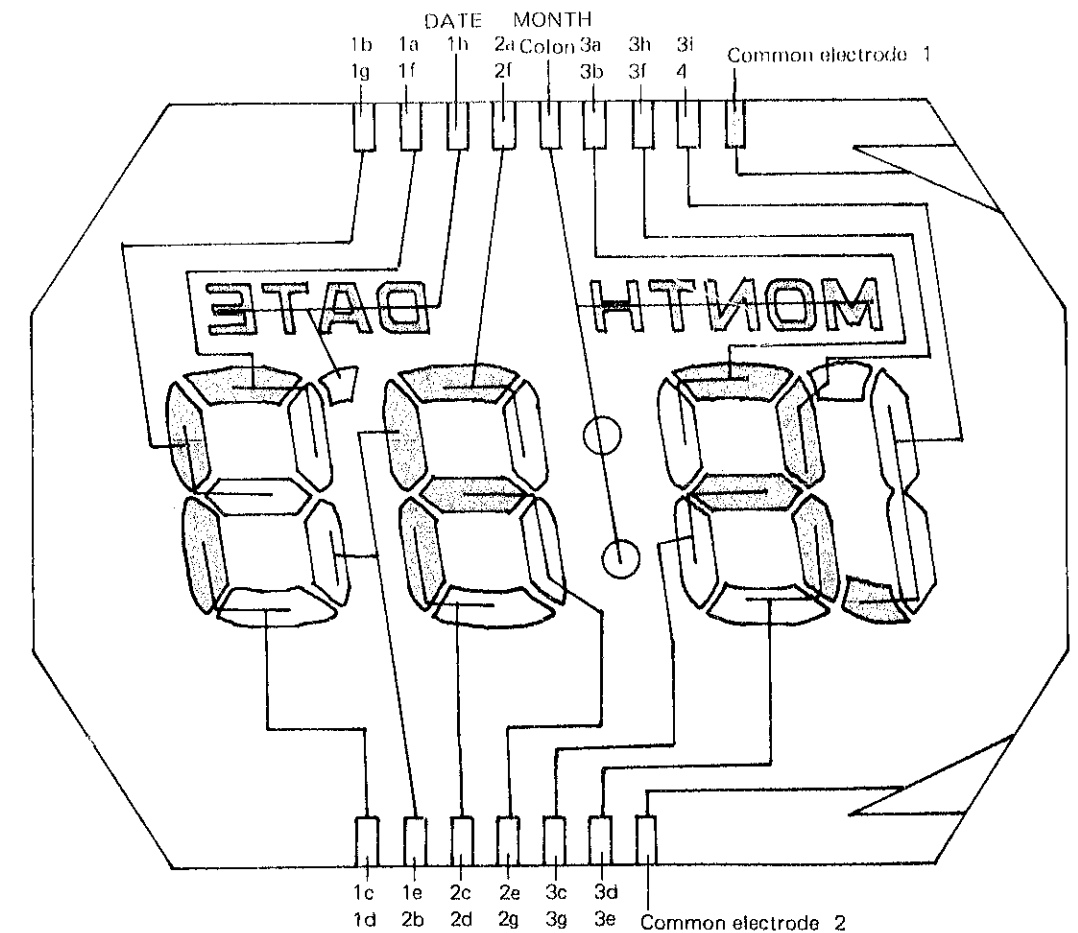

IV. CHECKING AND ADJUSTMENT

- Refer to the "SEIKO QUARTZ TECHNICAL GUIDE, GENERAL INSTRUCTION for Digital Watches" for details.

Procedure

CHECK BATTERY VOLTAGE

Result:
 More than 1.5 V Normal
 Less than 1.5 V Defective

CHECK PATTERN SEGMENT CHECKING SYSTEM

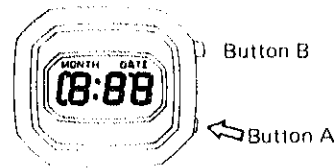

- Depress button A for 4 to 5 seconds, and all the segments light up.
- With all the segments lit, check to see if there is any defective segment. Depress either button A or B to return the time display.

CHECK CONDUCTIVITY OF LIQUID CRYSTAL PANEL, CIRCUIT BLOCK AND CONNECTORS

CHECK LIQUID CRYSTAL PANEL AND CIRCUIT BLOCK

- How to check the output voltage for the circuit block.

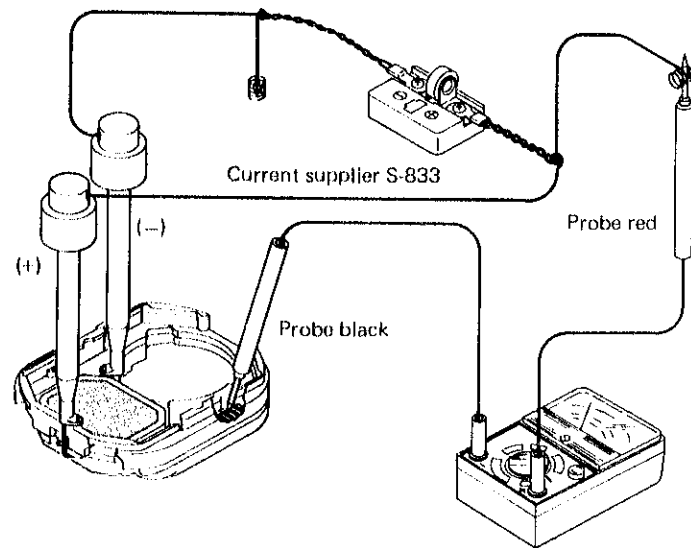

Result:
 More than 0.8 V Normal
 Less than 0.8 V Defective

[Current supplying position]

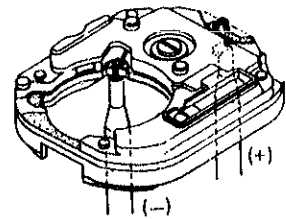

- Check the liquid crystal panel

Result:
 Lights up Normal
 Does not light up Defective

CHECK CURRENT CONSUMPTION

- Check the current consumption of the module after removing the switch spring, battery connection insulator, and battery connection (-).

Result:
 Less than 1.0μA . . . Normal
 *More than 1.0μA . . . Defective

*How to identify if the liquid crystal panel or circuit block is defective when the current consumption is more than 1.0μA. Disassemble the liquid crystal panel, reflecting mirror and connectors, and measure the current consumption.

Result:
 Less than 0.8μA . . . Replace the liquid crystal panel with a new one.
 More than 0.8μA . . . Replace the circuit block with a new one.

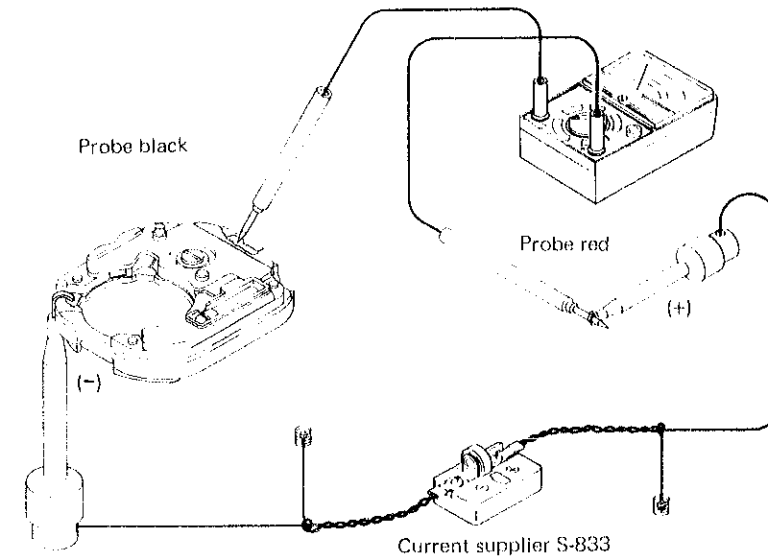

CHECK CONDUCTIVITY OF SWITCH COMPONENTS

CHECK ACCURACY

- Depress button A for 4 to 5 seconds, and all the segments light up. That facilitates measuring the daily rate.

CHECK FUNCTIONING AND ADJUSTMENT

- Depress button B and check to see if each display is shown for 2 seconds and automatically changed in the following order.

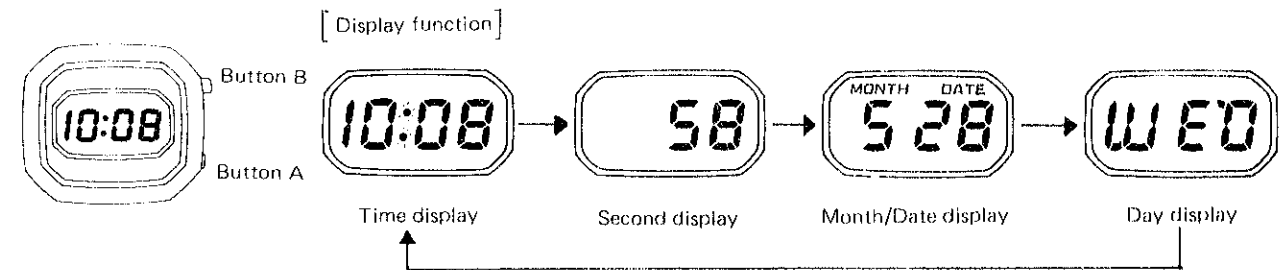

- Depress button B twice and check to see if the time display will return after the seconds are displayed for 4 to 5 minutes.
- Check to see if each display starts flashing to be adjusted by each depression of button A.
- Check to see if the flashing digit is advanced by each depression of button B.

All procedures of Disassembling, Reassembling, Checking and Adjustment are completed.